



MODEL TEMPF-HS-YT

MOBILE PUMP FILL STATION

GENERAL DESCRIPTION

The TUCS MOBILE PUMP FILLER provides rapid and precision metering of pumpable products from a kettle into casings or pouches and hermetically seals lay-flat pouches with a heat sealer. The volumetric pump can also fill pans, tubs, bowls, and buckets and transfer products between vessels or load vessels with pumpable products. Repeatable volumes are adjusted utilizing a precision lead screw.

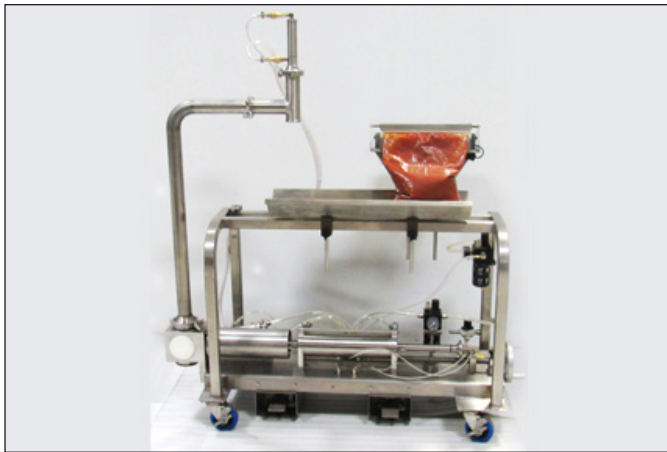

Tucs Model TEMPF-HS-YT

CERTIFICATIONS
NSF/ANSI-169



TUCS Equipment, Inc.
755 County Road 18 S. • Princeton MN 55371
Phone 763-574-7475 Fax 763-574-7472
www.tucsequipment.com

ITEM NO.

PROJECT

QUANTITY

AIA NO.

CONSTRUCTION & FEATURES

All stainless-steel construction type 316L product contact surfaces, type 304L elsewhere ■ Adjustable work surface to support pouch/casing during fill sequence ■ On/Off Switch ■ Empty pouch/casing holding tray ■ Engraved position scale for quick setup ■ Foot pedal initiation of pump sequence and heat sealer ■ Operator selection of single cycle or continuous (for product transfer or cleaning) and for actuating heat sealer ■ Pneumatic flow control to regulate cycle speed ■ Furnished with air filter/lubricator/regulator

PUMP HEAD AND METERING BARREL

Exclusive tapered ports to eliminate product damage ■ Double arm activation of rotary valve ■ Rotary valve sized for hot fill (160°F–190°F fill temperatures) – other fill temperatures available (see chart on back before ordering) ■ Head block dairy clamp connections: 3-inch inlet, 2½-inch discharge ■ 6-inch Dia. metering barrel – 136 oz. capacity ■ Quick disconnect product metering plunger adjustable from 32 oz. to 136 oz. ■ Stainless steel drive cylinder

DISCHARGE NOZZLE

2-inch fill nozzle with heat shield ■
Air-activated plunger for dripless cut-off

SEALING

Heat Sealer (-HS) ■ Electric, Single-band heat seal ■ Adjustable seal time and temperature ■ Optional Tipper Tie Clipper (-TT) Model SZ-4135L ■ Air Operated ■ Automatic clip feed, safety shutoff valve and air pressure gauge

INCLUDED OPTIONS

Two (2) sections of 3" dia. x 3" dia. x 3' long USDA approved food transfer inlet hose with dairy clamp fittings ■ 10' length of compressed air hose with quick disconnects ■ Spare Parts Kits ■ TEBK-brush cleaning kit

OPTIONS

- Fill temperature monitoring
- Cold fill piston accessories (Verify Temp.)



MODEL TEMPF-HS-YT

MOBILE PUMP FILL STATION

Scan this QR code with your smart phone to visit our website for more information.

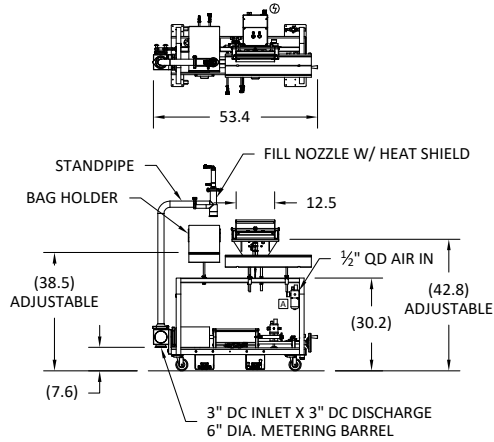

TEMPF-HS-YT MOBILE PUMP FILL STATION WITH HEAT SEALER

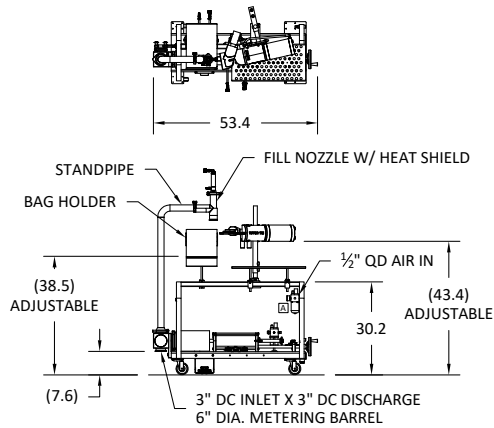
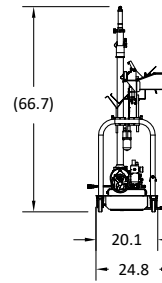

OPTIONAL TEMPF-TT-YT MOBILE PUMP FILL STATION WITH TIPPER TIE®

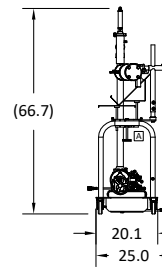

DIMENSIONS					
BLOCK SIZE (Y)	B	C	D	E	F
DIAMETER	2 1/4"	3"	3 1/2"	4"	4"
BLOCK LENGTH	3"	4"	5"	5"	6"
BASE WIDTH	6"	11"	12"	12"	12"
BASE LENGTH	24"	42"	43"	43"	43"

RECOMMENDED CLEARANCES	
RIGHT SIDE	12"
BACK	12"
LEFT SIDE	12"

ROTARY VALVE TYPE		
SUFFIX (T)	DESCRIPTION	TEMP RANGE
CC	COLD COLD	30°F - 40°F
C	COLD	45°F - 65°F
R	ROOM	65°F - 90°F
W	WARM	90°F - 140°F
H	HOT	140°F - 185°F
HH	HOT HOT	185°F - 205°F

UTILITIES		
SYM	DESCRIPTION	UTILITY CONNECTION
A	COMPRESSED AIR	1/2" QUICK DISCONNECT - 15 CFM @ 90 PSI
⊕	ELECTRICAL	6.0 FLA @ 110 VAC W/ 3 PRONG CORD (-HS MODEL ONLY)

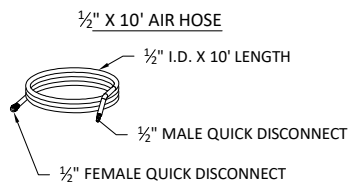

3.0 DIA. FLEXIBLE INLET HOSE - TEITP

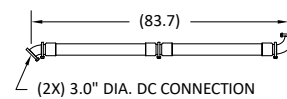

- INCLUDED:
- TEITP - TWO (2) SECTIONS OF 3" DIA. X 3' LONG USDA APPROVED FOOD TRANSFER INLET HOSES WITH DAIRY CLAMPS, GASKETS AND ELBOWS
 - 10' LENGTH OF COMPRESSED AIR HOSE WITH QUICK DISCONNECTS
 - TEBK - CLEANING BRUSH KIT
 - SPARE PARTS KIT
 - FILL NOZZLE (VARIETY OF SIZES AVAILABLE)